

S20 SERIES

The **S20** series offers all the basic optic functions at the highest operating distances. The series presents models with 50 cm background suppression with microprocessor-based Teach-in setting or, with trimmer adjustment, 10 m polarised retroreflex, 2 m diffuse proximity and 50 m emitter-receiver optic functions. Even with particular compact dimensions, these sensors guarantee optimal performances, thanks to special aspherical lenses that take full advantage of the high-power LED emission, visible red in the background suppression and polarised retroreflex versions and infrared in all the other models. Both NO and NC outputs are present in the NPN or PNP versions. M12 connector is available. The connection block can be adjusted either in a straight or right angle position, in order to offer improved mounting versatility.



HIGHLIGHTS

- Enhanced emission and special lenses ideal for long operating distances
- μ P Teach-in setting for background suppression
- Orientable M12 connector
- Impermeable, compact and resistance plastic housing

APPLICATIONS

Automotive



Conveyors



Automatic warehouse



CONNECTIONS

S20-x-B/C/M/F

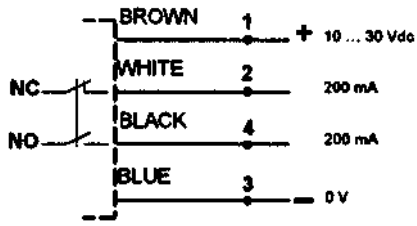

S20-x-G

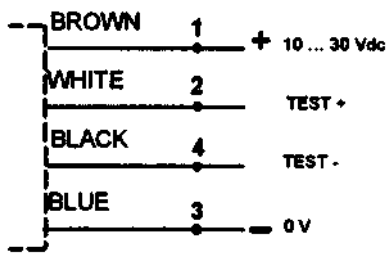

M12 CONNECTOR

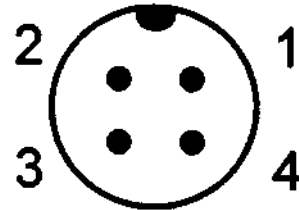

DIMENSIONS

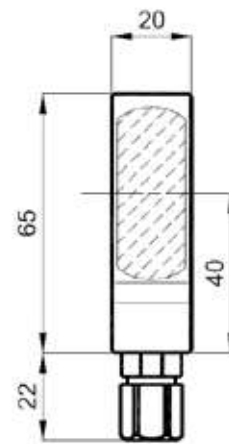
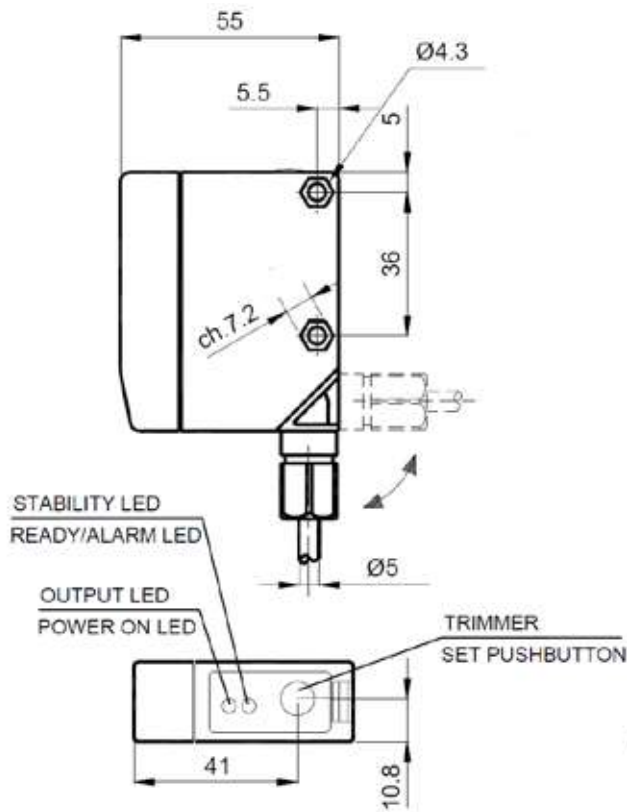

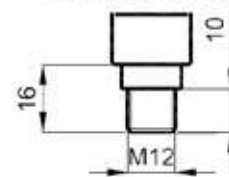

M12 CONNECTOR



mm

TECHNICAL DATA

Power supply:	10 ... 30 Vdc, reverse polarity protection
Consumption:	50 mA max.
Light emission:	red LED 660 nm (B, M vers.) infrared LED 880 nm (C, F/G vers.)
Diffuse proximity operating distance:	1... 200 cm
Background suppression op. distance:	10 ... 50 cm
Polarised retroreflex operating distance:	0.1 ... 7 m (on R2)
Through beam operating distance:	0.1 ... 50 m
Setting:	sensitivity trimmer (B, C, F vers.) SET push-button (M vers.)
Indicators:	yellow OUTPUT LED green STABILITY LED (B, C, F vers.) green READY LED (M vers.) red ALARM LED (M vers.)
Output type:	NO-NC NPN or PNP, open collector
Saturation voltage:	1 V max. (NPN vers.) 2 V max. (PNP vers.)
Output current:	200 mA max., short-circuit protection
Response time:	1 ms max.
Switching frequency:	500 Hz max.
Connection:	M12 4-pole connector
Electrical protection:	class 2
Mechanical protection:	IP66
Housing material:	ABS
Lens material:	PMMA plastic
Weight:	50 g max.
Functioning temperature:	-25 ... +55°C -10 ... +55°C (M vers.)
Storage temperature:	-25 ... +70°C
Reference standard:	EN 60947-5-2
Certifications:	 

DETECTION DIAGRAMS

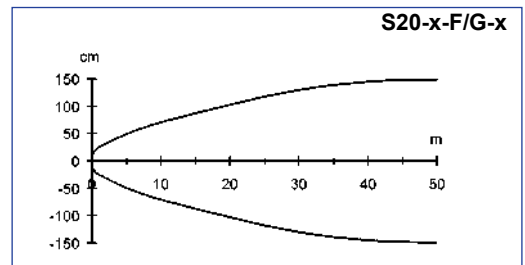
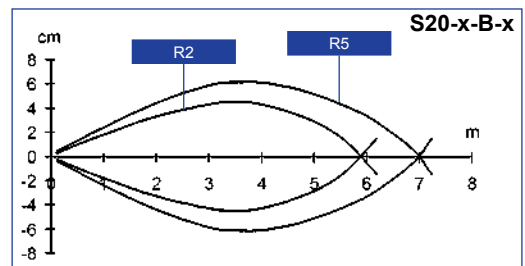
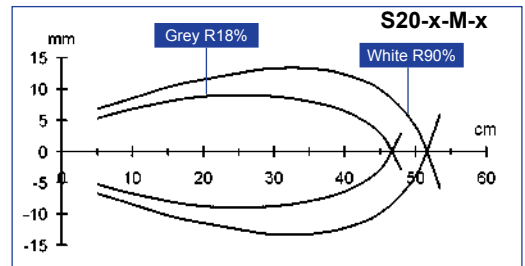
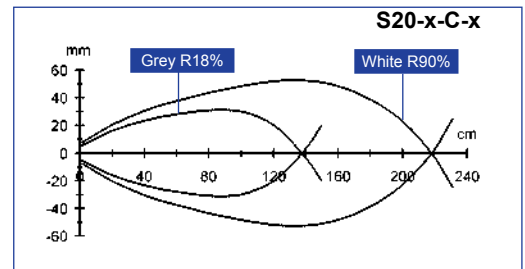

The operating distances indicate the detection distance with excess gain 2.



The detection diagrams indicate the typical operating distance with excess gain 1.

MODEL SELECTION AND ORDER INFORMATION

MODEL	OPTIC FUNCTION	CONNECTION	OUTPUT	CODE N°
S20-5-C-P	diffuse proximity	M12 connector	PNP	951351110
S20-5-C-N	diffuse proximity	M12 connector	NPN	951351160
S20-5-M-P	background suppression	M12 connector	PNP	951351120
S20-5-M-N	background suppression	M12 connector	NPN	951351170
S20-5-B-P	polarised retroreflex	M12 connector	PNP	951351100
S20-5-B-N	polarised retroreflex	M12 connector	NPN	951351150
S20-5-F-P	receiver	M12 connector	PNP	951351130
S20-5-F-N	receiver	M12 connector	NPN	951351180
S20-5-G	emitter	M12 connector	-	951351140
S20-2-C-P	diffuse proximity	cable	PNP	951351010
S20-2-C-N	diffuse proximity	cable	NPN	951351060
S20-2-M-P	background suppression	cable	PNP	951351020
S20-5-G	polarised retroreflex	cable	PNP	951351000
S20-5-G	through beam	cable	-	951351040
S20-5-G	through beam	cable	PNP	951351030

ACCESSORY SELECTION AND ORDER INFORMATION

MODEL	DESCRIPTION	CODE N°
ST-164	1 pc fixing bracket	95ACC1340

Please refer also to *Sensor Accessories*